

## LU 1200 LEIVINUUNI

Peruskokoinen PT tiili	~410 kpl
MRT 60 kuorimuuraukseen	~320 kpl
TTT tulitiili, 257/123/57	~143 kpl
MTT tulitiili,257/85/57	~5kpl
Saviuunilaasti	~400 kg
Tulenkestävä valumassa	~325 kg
M100/600, muurauslaasti kuoreen	~300 kg
Tulenkestävä muurauslaasti	~50kg
TUL 10, tulisijalevy	~9m <sup>2</sup>
PAL50, palonsuojalevy	~1,2m <sup>2</sup>
LU-luukku 410/230-180 taustalevyllä	1
Tuhkapesän luukku270/130, muurausholkkeineen	2
Nuohous 130/130, holkkeineen	2
Arinamurska,hiekka,murskattu lasi	~26 L
Häkäputki 60/60/3'pituus tapauskohtainen	1
Sulkumekanismi , teetettävä	1

# LEIVINUUNI 1200

## A-A

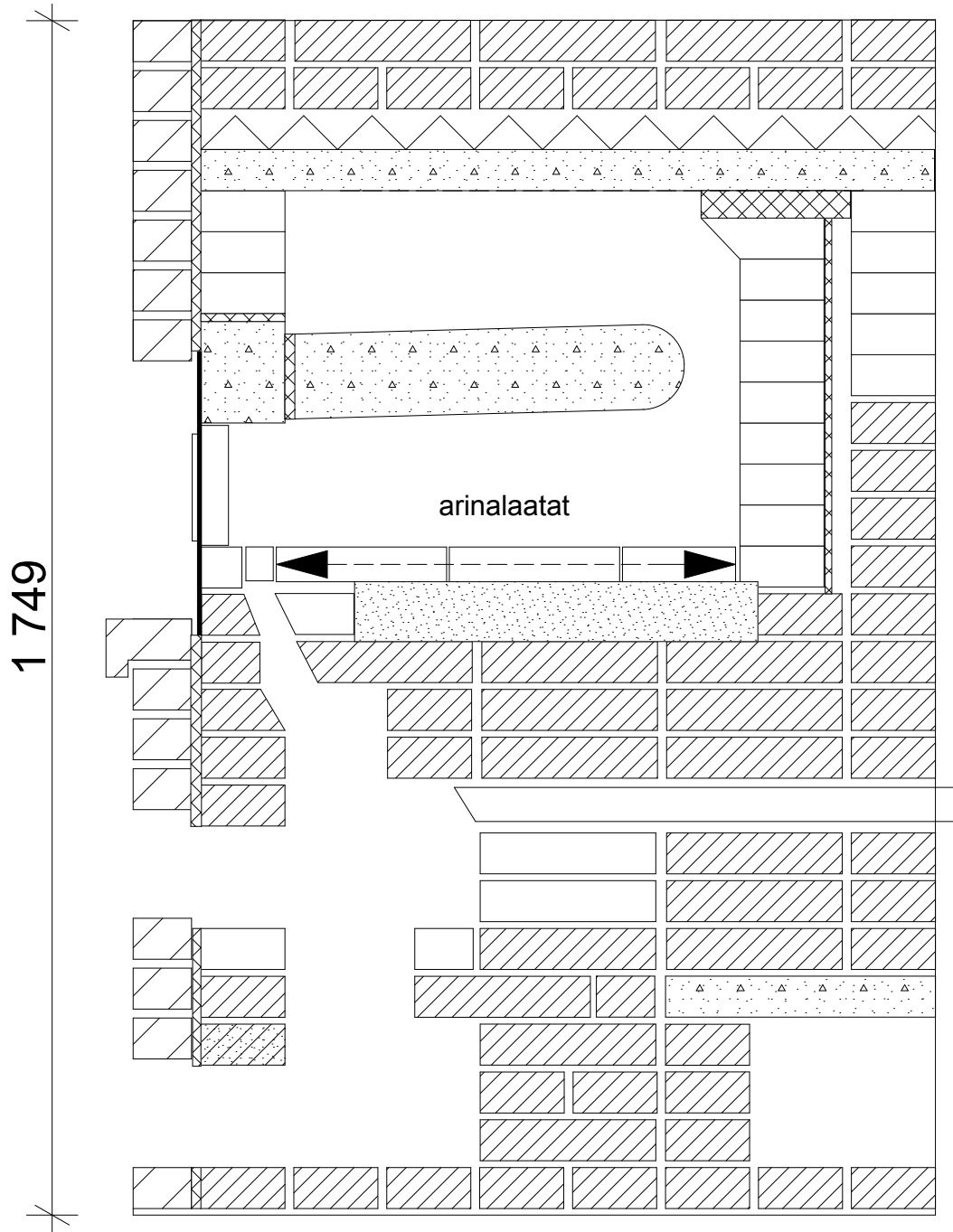

LEIVINUUNI 1200

B-B

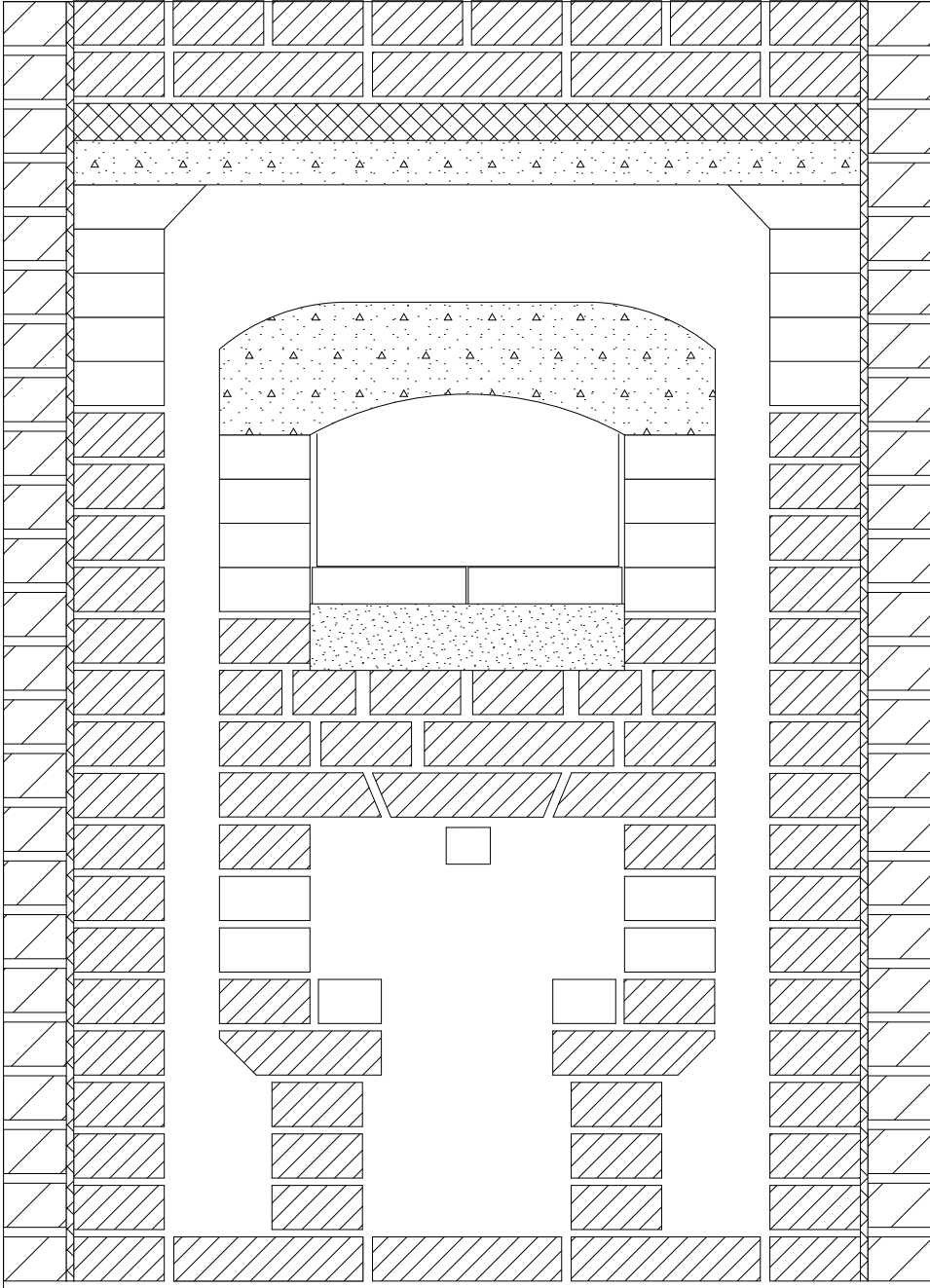

LEIVINUUNI 1200

Näkymä edestä

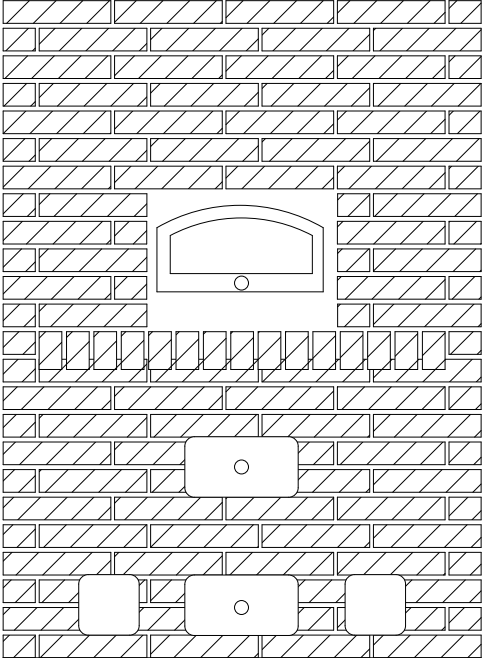

Näkymä oikealta

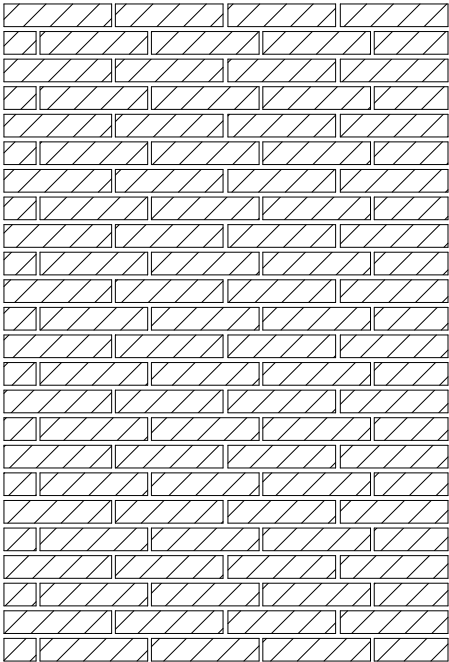

LEIVINUUNI 1200

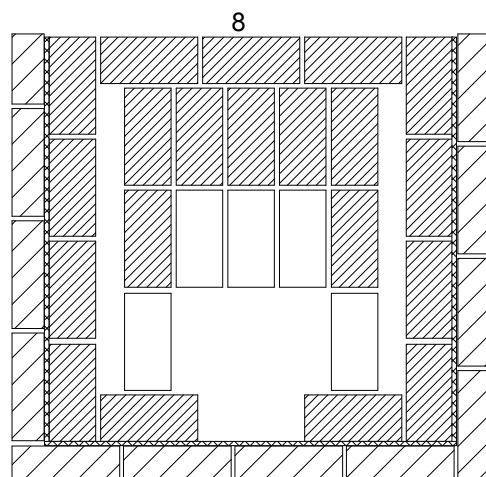
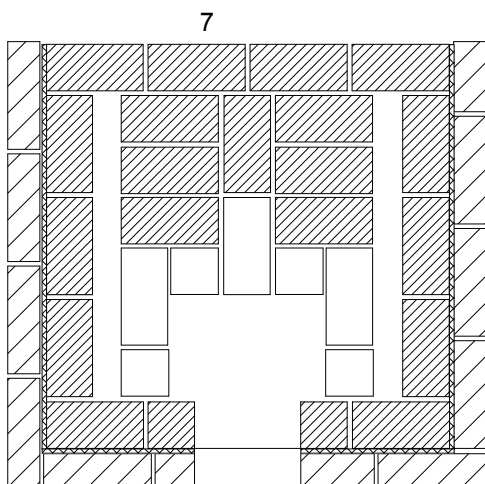
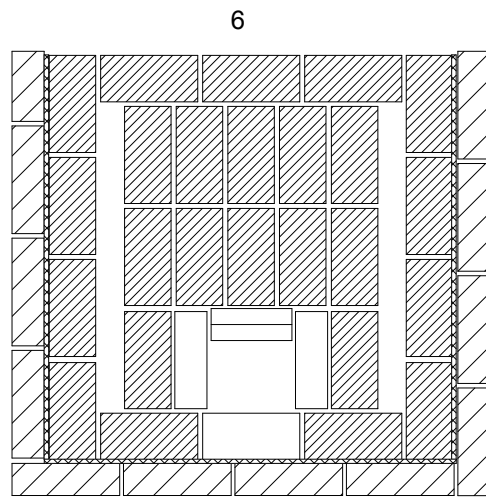
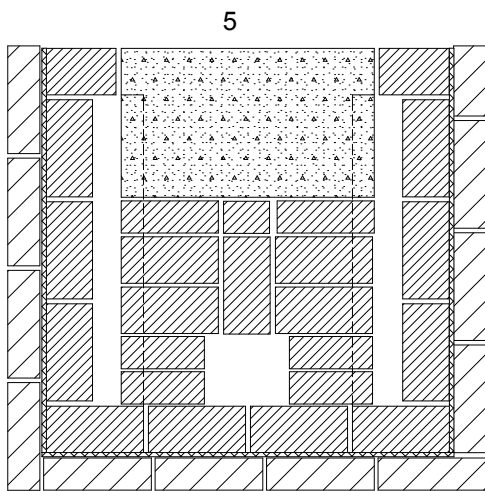
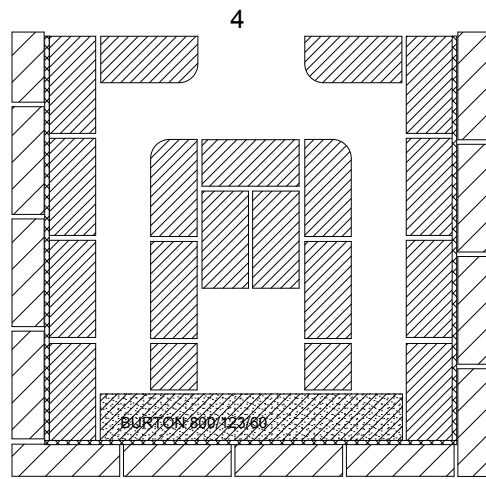
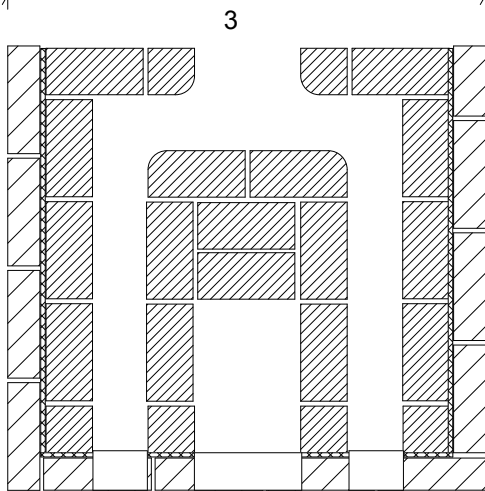
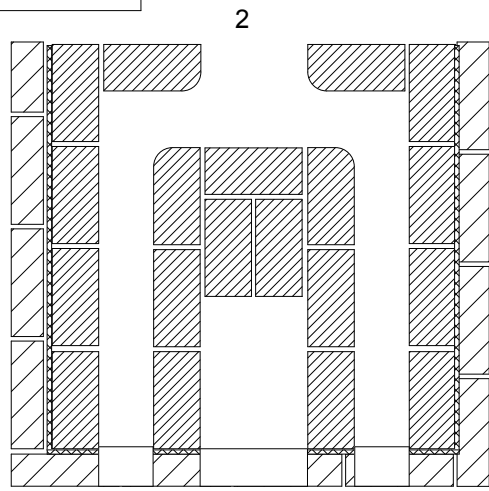
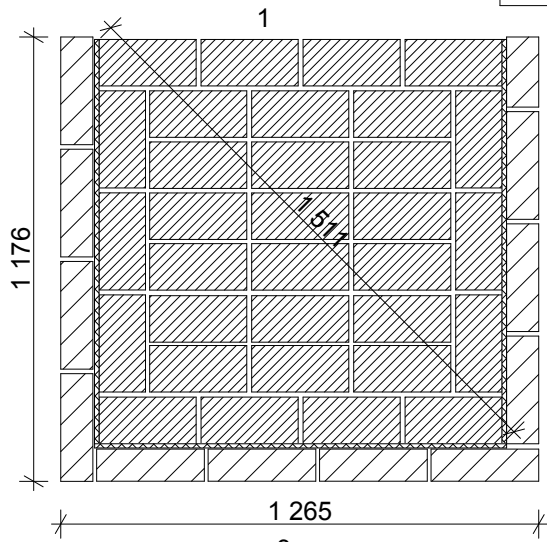

LEIVINUUNI 1200

9

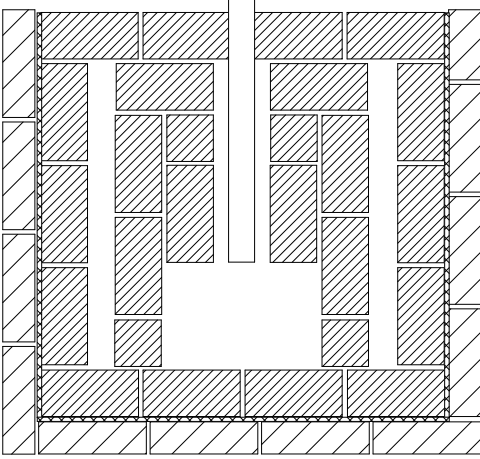

10

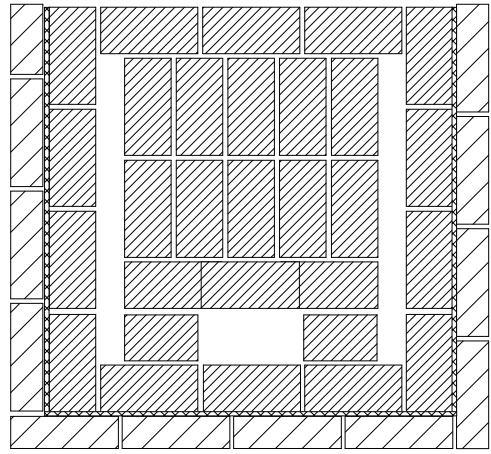

11

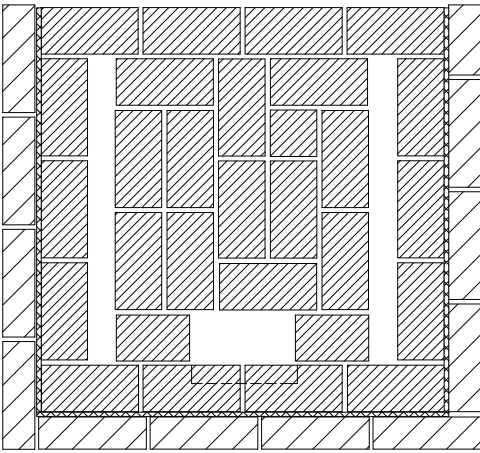

12

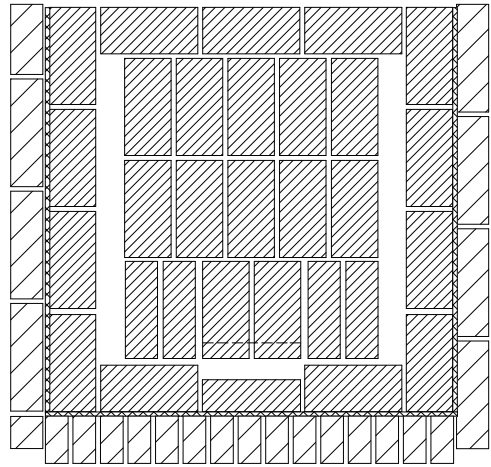

13

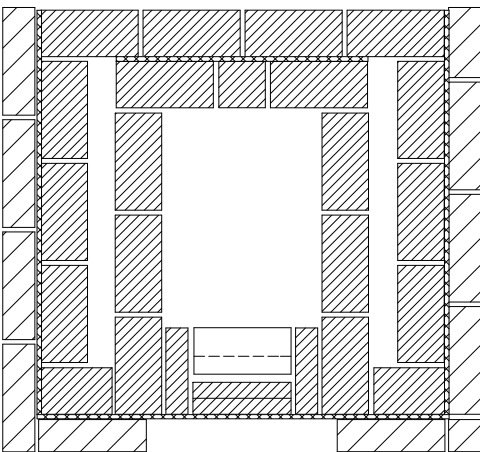

14

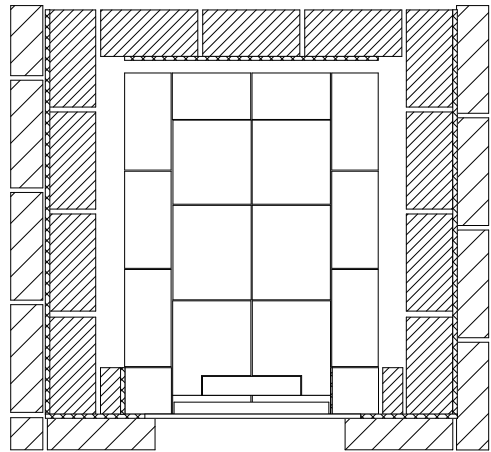

15

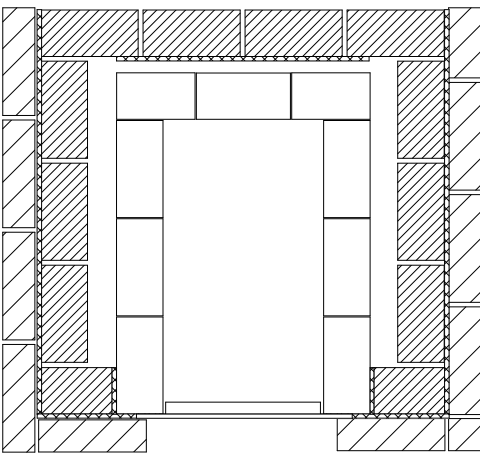

16

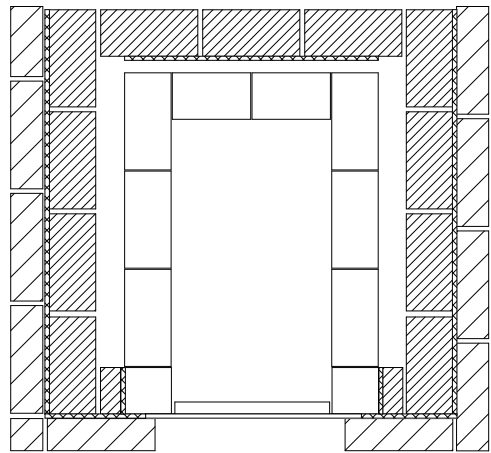

LEIVINUUNI 1200

17

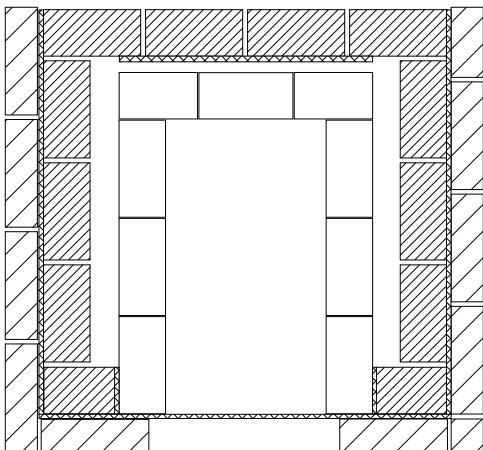

18

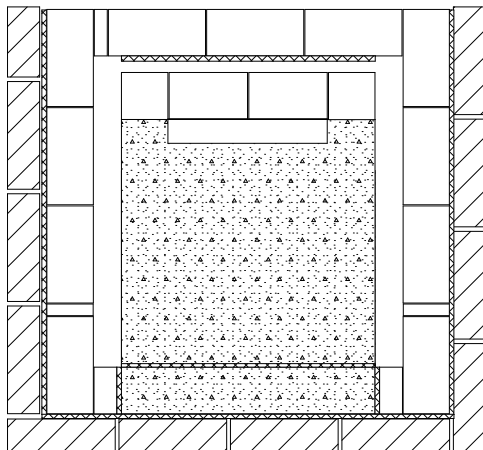

19

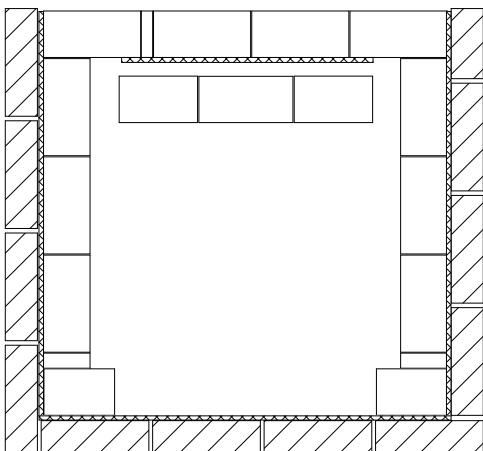

20

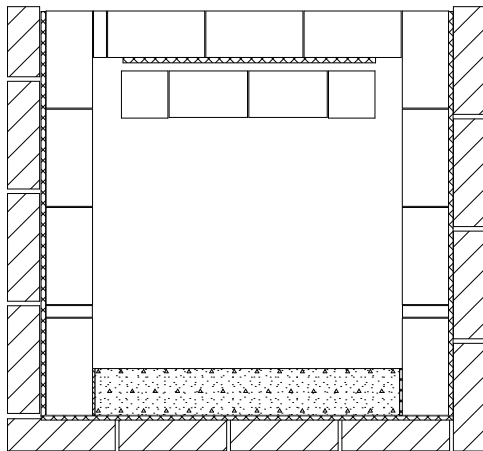

21

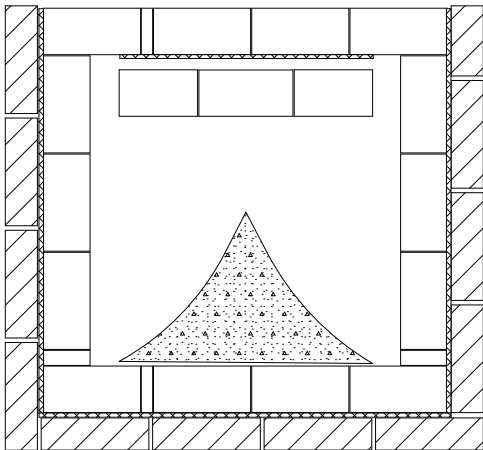

22

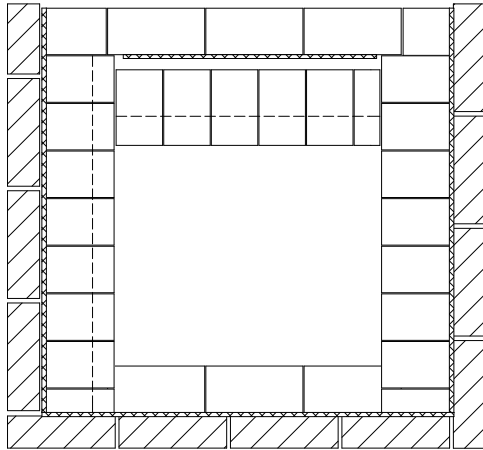

23

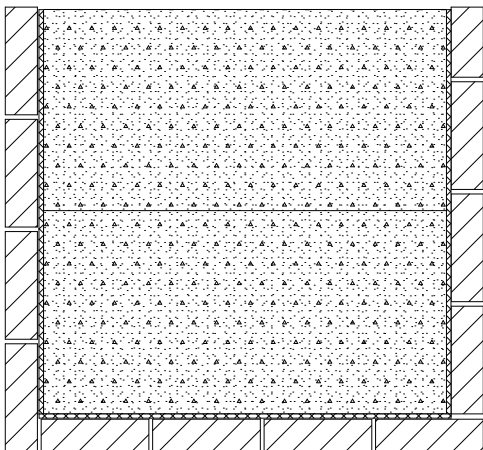

24

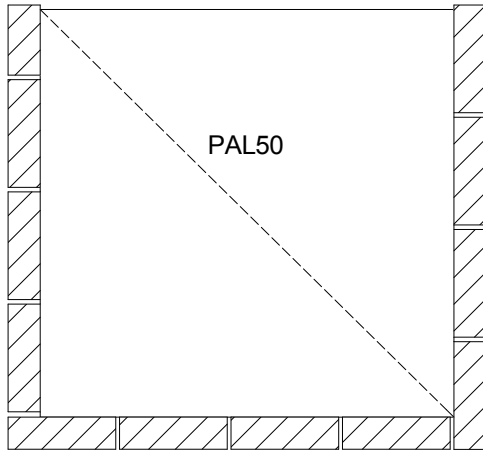

LEIVINUUNI 1200

25

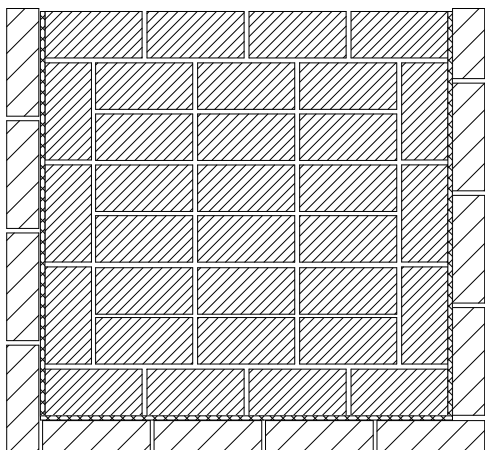

26

